

GOTHENBURG CEMETERY  
DAWSON COUNTY, NEBRASKA

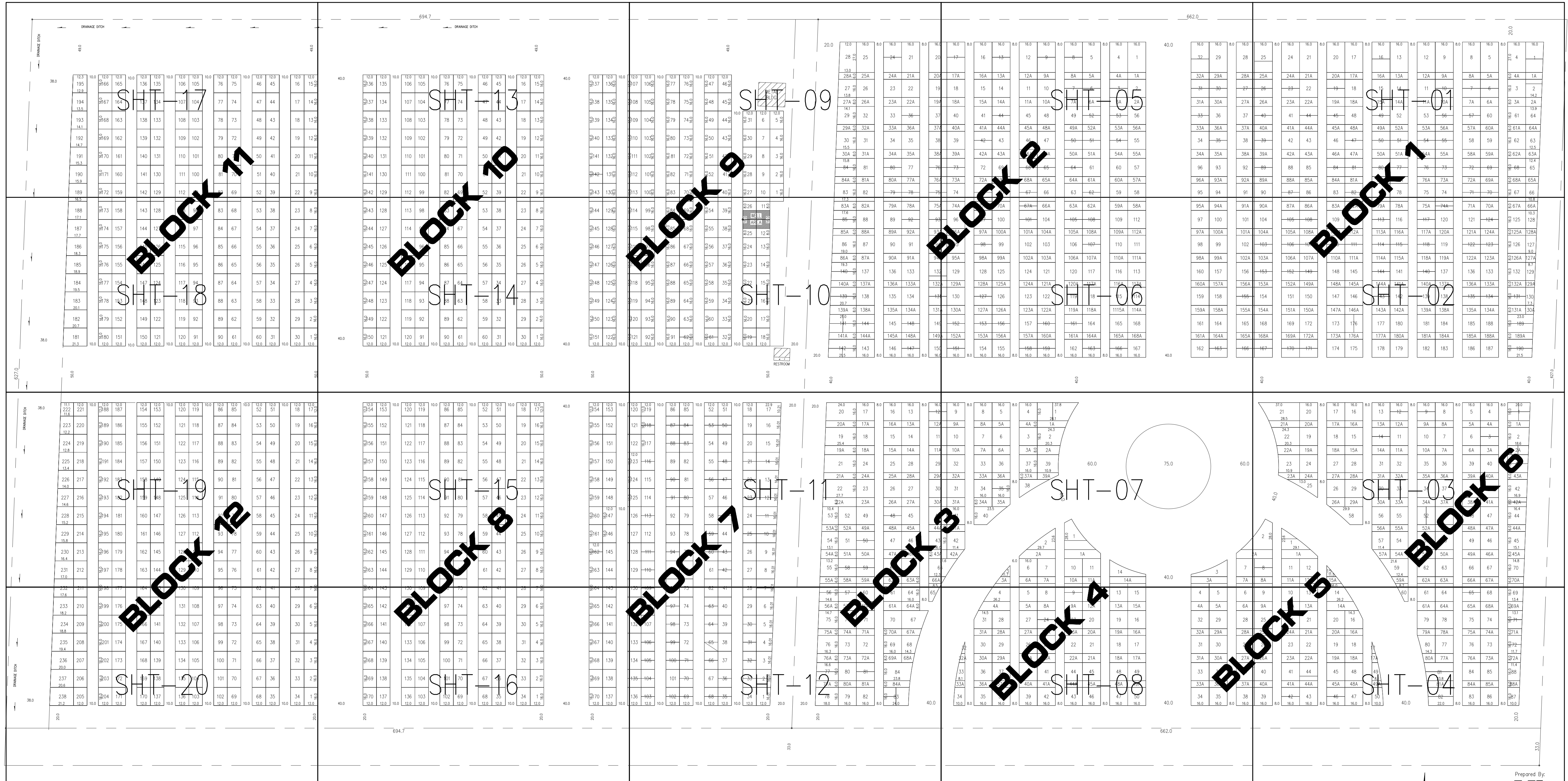

NOV. 04. 2001. 4:18:08:45 G:\Projects\126\126-G1-012-01\PI01-MAP.dwg  
MKT 126-012-01.dwg © 2001 Miller & Associates

Prepared By:  
**MA**  
Miller & Associates  
Consulting Engineers, P.C.  
1111 Central Avenue  
Kearney, NE 68847  
Tel. (308) 234-6456

INDEX PREPARED BY: MILLER & ASSOCIATES - 1111 CENTRAL AVENUE - KEARNEY, NE

LOTS

NOV 04, 2001 4:18:09:15 G:\Projects\126\126-G1-012-01\SHIT-01.dwg

16.0	16.0	8.0	16.0	16.0	8.0	16.0	16.0	8.0	16.0	16.0	8.0	16.0	16.0	8.0	16.0	16.0	8.0	16.0	16.0	20.0	16.0	16.0	
28	25		24	21		20	17		16	13		12	9		8	5		27.0	4		1		
28A	25A		24A	21A		20A	17A		16A	13A		12A	9A		8A	5A		6.0	4A		1A		
27	26		23	22		19	18		15	14		11	10		7	6		16.0	3		2	14.2	
27A	26A		23A	22A		19A	18A		15A	14A		11A	10A		7A	6A		8.0	3A		2A		
37	40		41	44		45	48		49	52		53	56		57	60		16.0	61		13.9	64	
37A	40A		41A	44A		45A	48A		49A	52A		53A	56A		57A	60A		6.0	61A		64A		
38	39		42	43		46	47		50	51		54	55		58	59		16.0	62		63	12.5	
38A	39A		42A	43A		46A	47A		50A	51A		54A	55A		58A	59A		8.0	62A		63A		
92	89		88	85		84	81		80	77		76	73		72	69		16.0	68		65	12.4	
92A	89A		88A	85A		84A	81A		80A	77A		76A	73A		72A	69A		6.0	68A		65A		
91	90		87	86		83	82		79	78		75	74		71	70		16.0	67		66	10.8	
91A	90A		87A	86A		83A	82A		79A	78A		75A	74A		71A	70A		8.0	67A		66A		
																						10.3	

LOTS

SHT.- 01

PREPARED BY: MILLER & ASSOCIATES - 1111 CENTRAL AVENUE - KEARNEY, NE



NOV 04, 2001 4:18:09:27 G:\Projects\126\126-G1-012-01\SH1-02.dwg

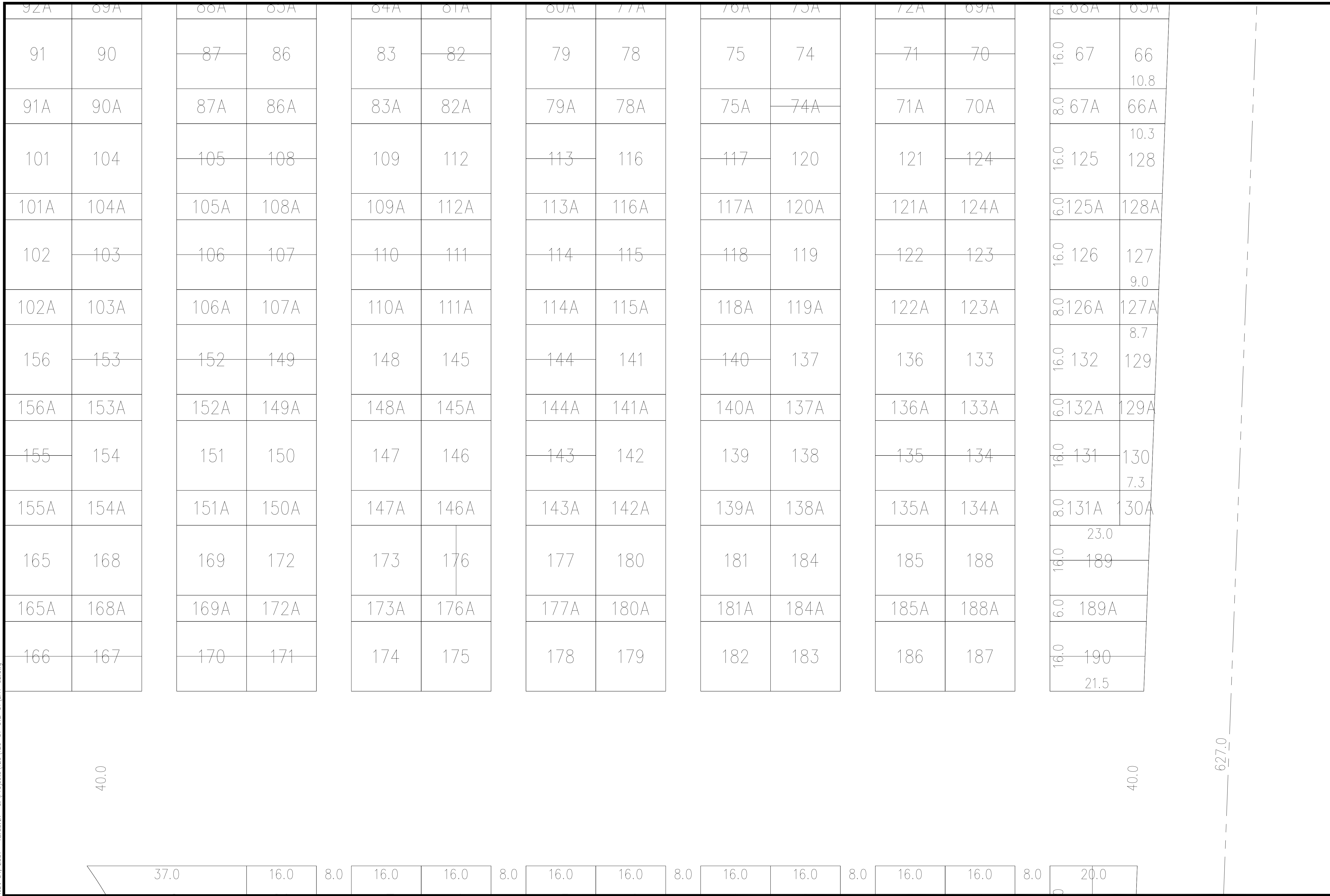

LOTS

SHT.- 02

PREPARED BY: MILLER & ASSOCIATES - 1111 CENTRAL AVENUE - KEARNEY, NE

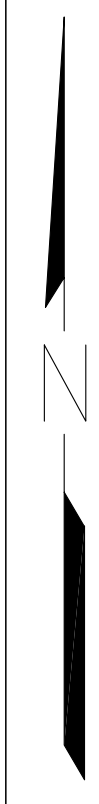

NOV 04, 2001 1:18:09:38 G:\Projects\126\126-G1-012-01\SH1-03.dwg

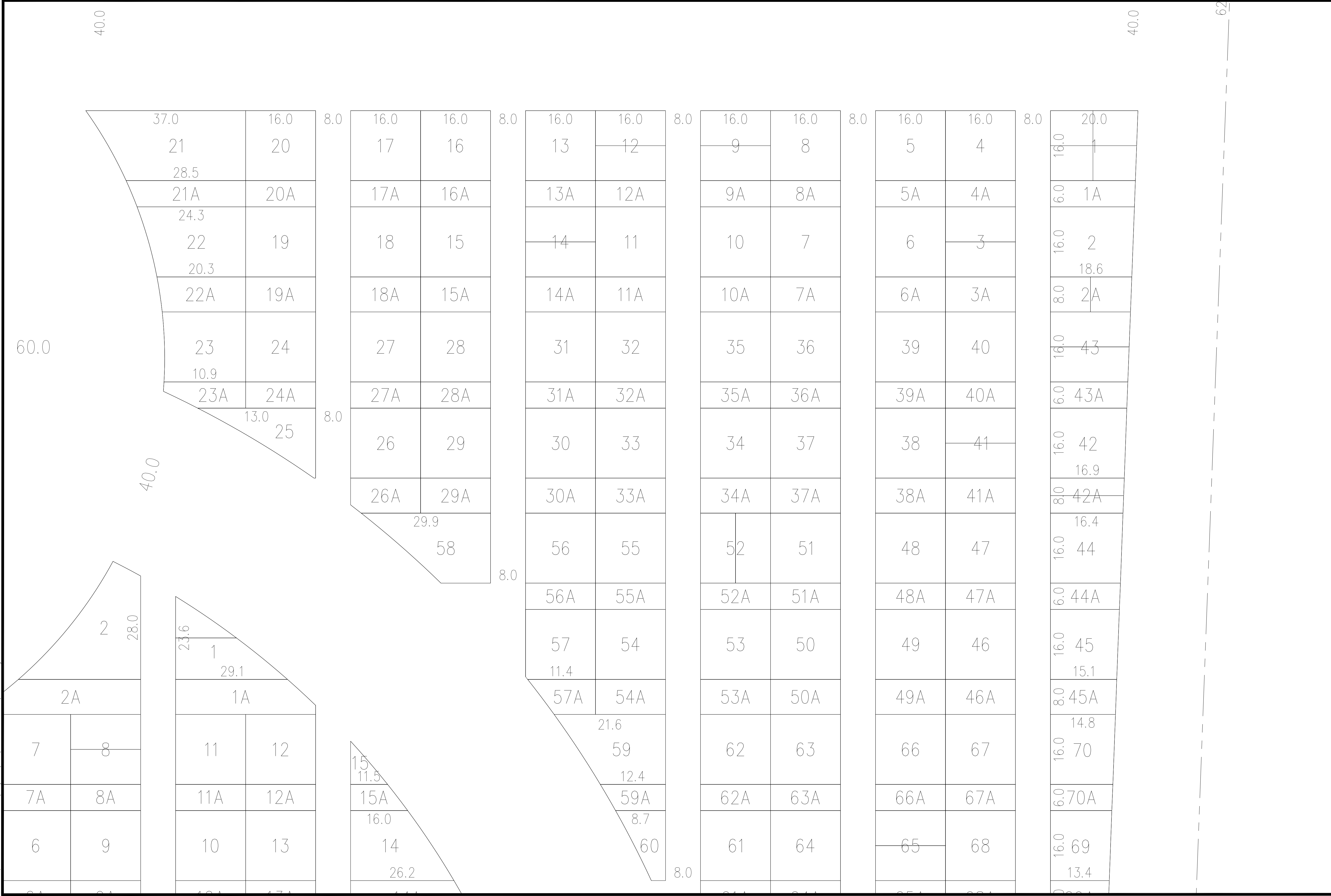

LOTS

SH1.- 03

PREPARED BY: MILLER & ASSOCIATES - 1111 CENTRAL AVENUE - KEARNEY, NE



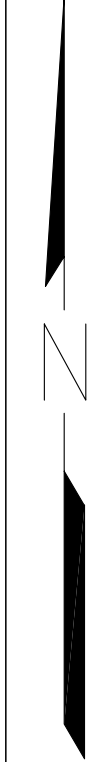

NOV 04, 2001 1:18:09:53 G:\Projects\126\126-G1-012-01\SHIT-05.dwg

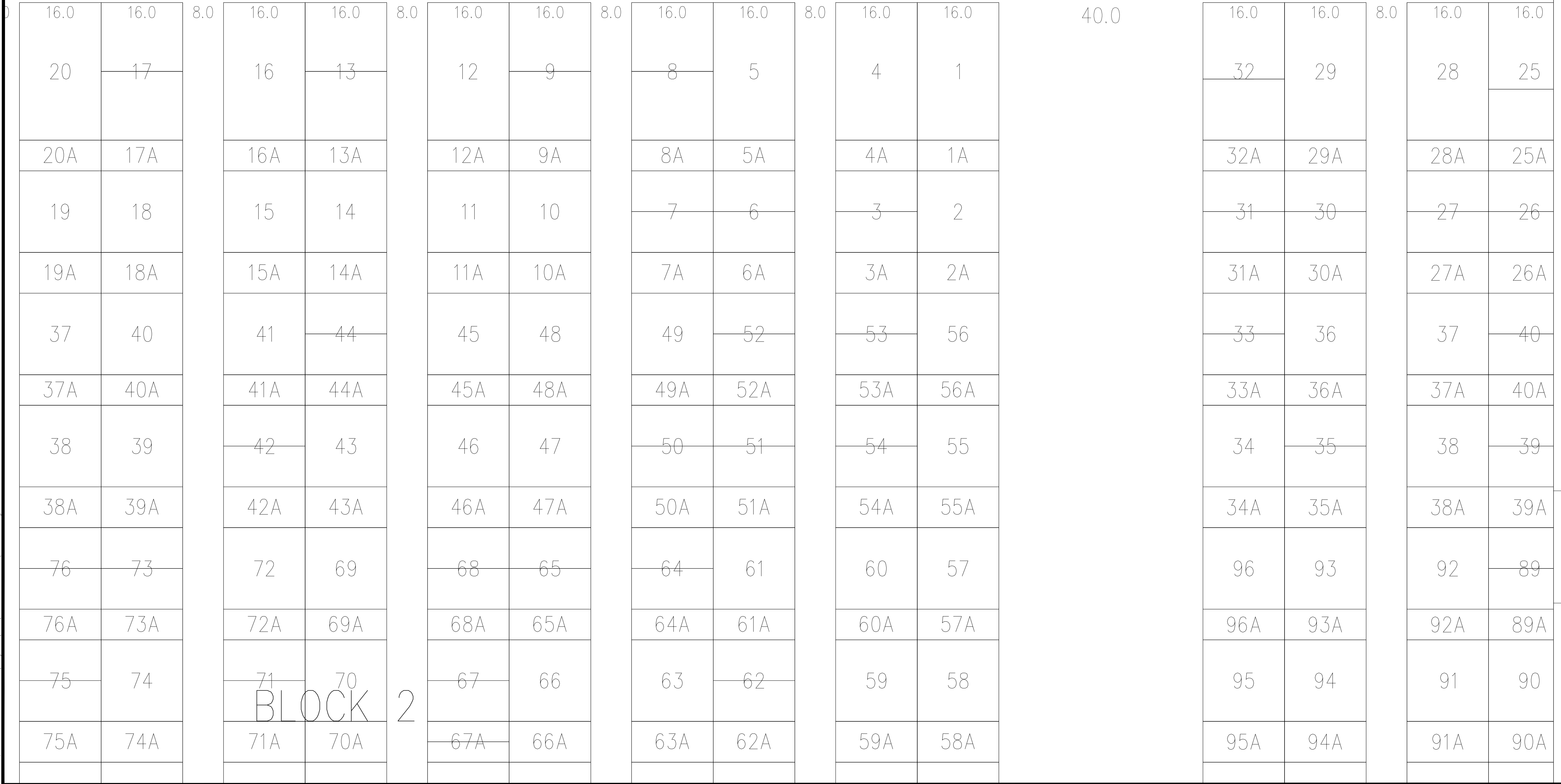

BLOCK 2

662.0

40.0

LOTS

SHIT.- 05

PREPARED BY: MILLER & ASSOCIATES - 1111 CENTRAL AVENUE - KEARNEY, NE

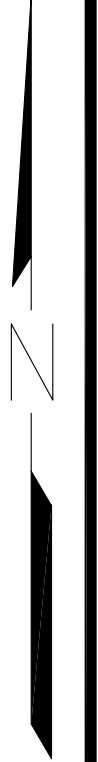

NOV 04, 2001 4:18:10:04 G:\Projects\126\126-G1-012-01\SHIT-06.dwg

76A	75A		72A	69A		66A	63A		64A	61A		58A	57A		96A	93A		92A	89A
75	74		71	70		67	66		63	62		59	58		95	94		91	90
75A	74A		71A	70A		67A	66A		63A	62A		59A	58A		95A	94A		91A	90A
93	96		97	100		101	104		105	108		109	112		97	100		101	104
93A	96A		97A	100A		101A	104A		105A	108A		109A	112A		97A	100A		101A	104A
94	95		98	99		102	103		106	107		110	111		98	99		102	103
94A	95A		98A	99A		102A	103A		106A	107A		110A	111A		98A	99A		102A	103A
132	129		128	125		124	121		120	117		116	113		160	157		156	153
132A	129A		128A	125A		124A	121A		120A	117A		116A	113A		160A	157A		156A	153A
131	130		127	126		123	122		119	118		115	114		159	158		155	154
131A	130A		127A	126A		123A	122A		119A	118A		1115A	114A		159A	158A		155A	154A
149	152		153	156		157	160		161	164		165	168		161	164		165	168
149A	152A		153A	156A		157A	160A		161A	164A		165A	168A		161A	164A		165A	168A
150	151		154	155		158	159		162	163		166	167		162	163		166	167
16.0	16.0	8.0	16.0	16.0	8.0	16.0	16.0	8.0	16.0	16.0	8.0	16.0	16.0	40.0					

BLOCK 2



PREPARED BY: MILLER & ASSOCIATES - 1111 CENTRAL AVENUE - KEARNEY, NE

SHT. - 06

LOTS

16.0	16.0	8.0	16.0	16.0	8.0	16.0	37.8
------	------	-----	------	------	-----	------	------

40.0

NOV 04, 2001 11:18:10 6:\Projects\126\126-G1-012-01\SH1-07.dwg

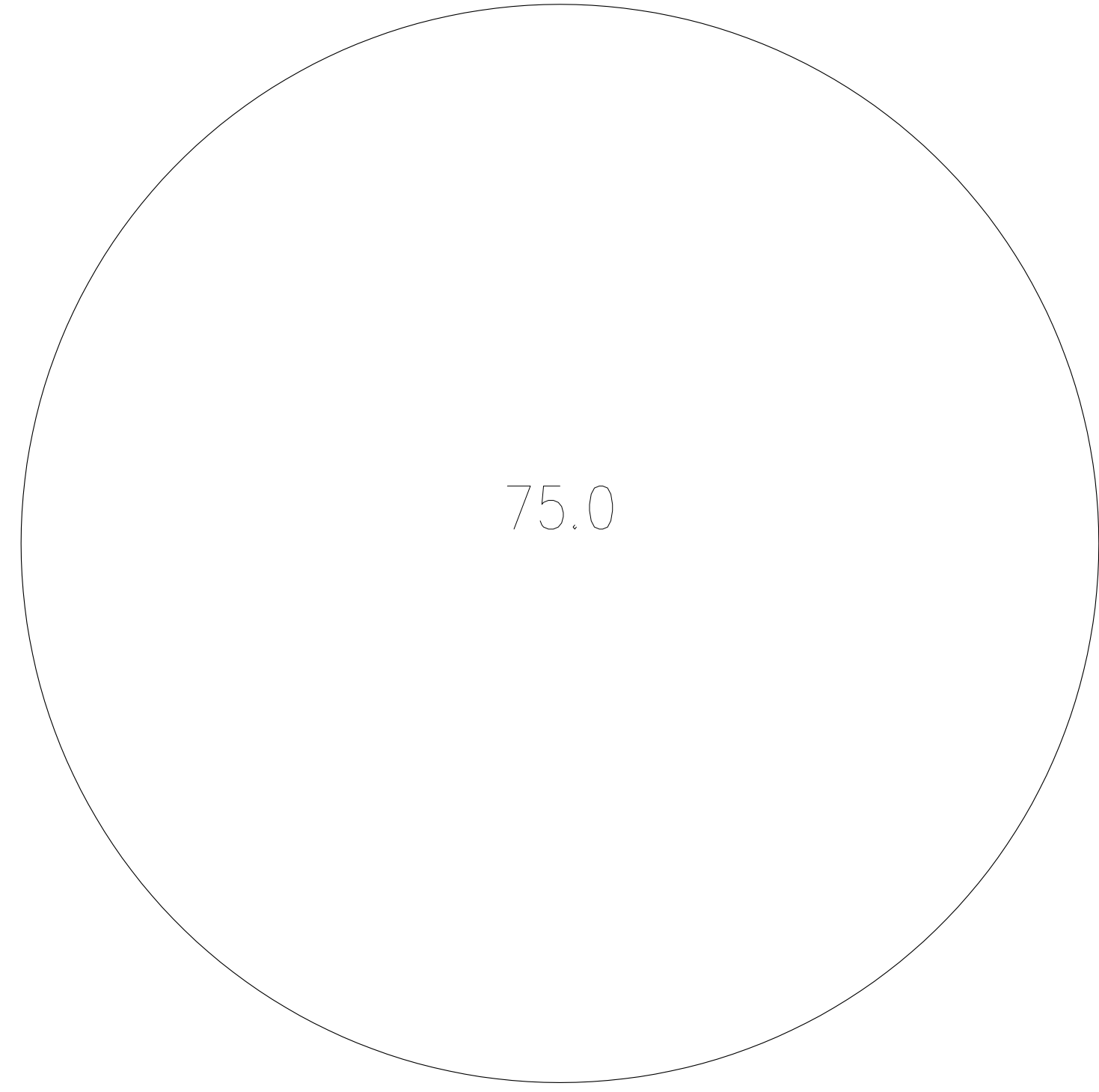
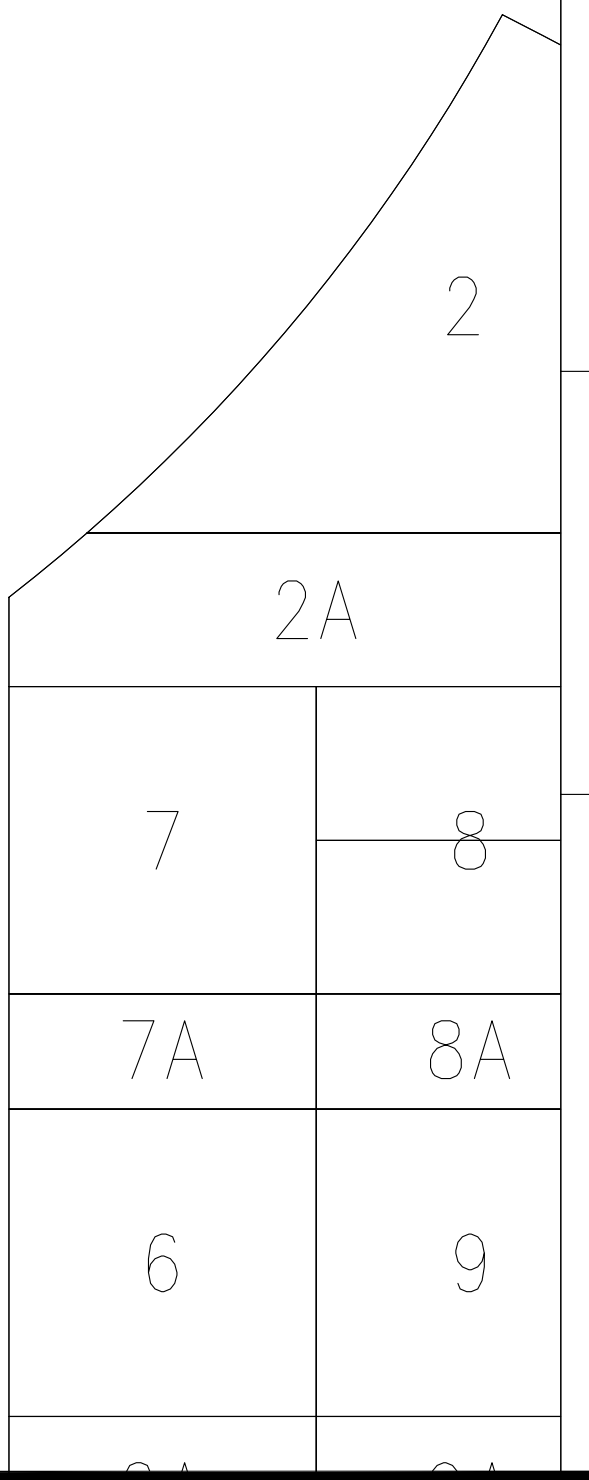
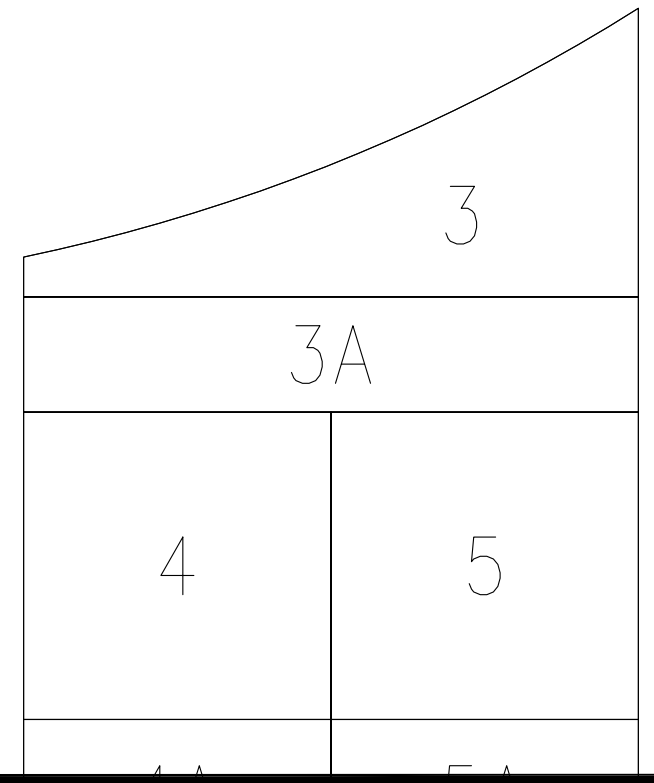
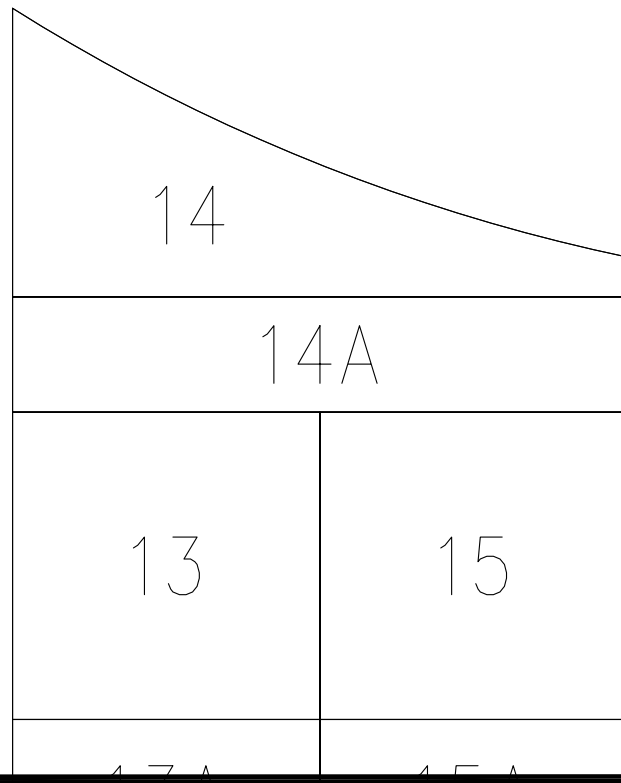
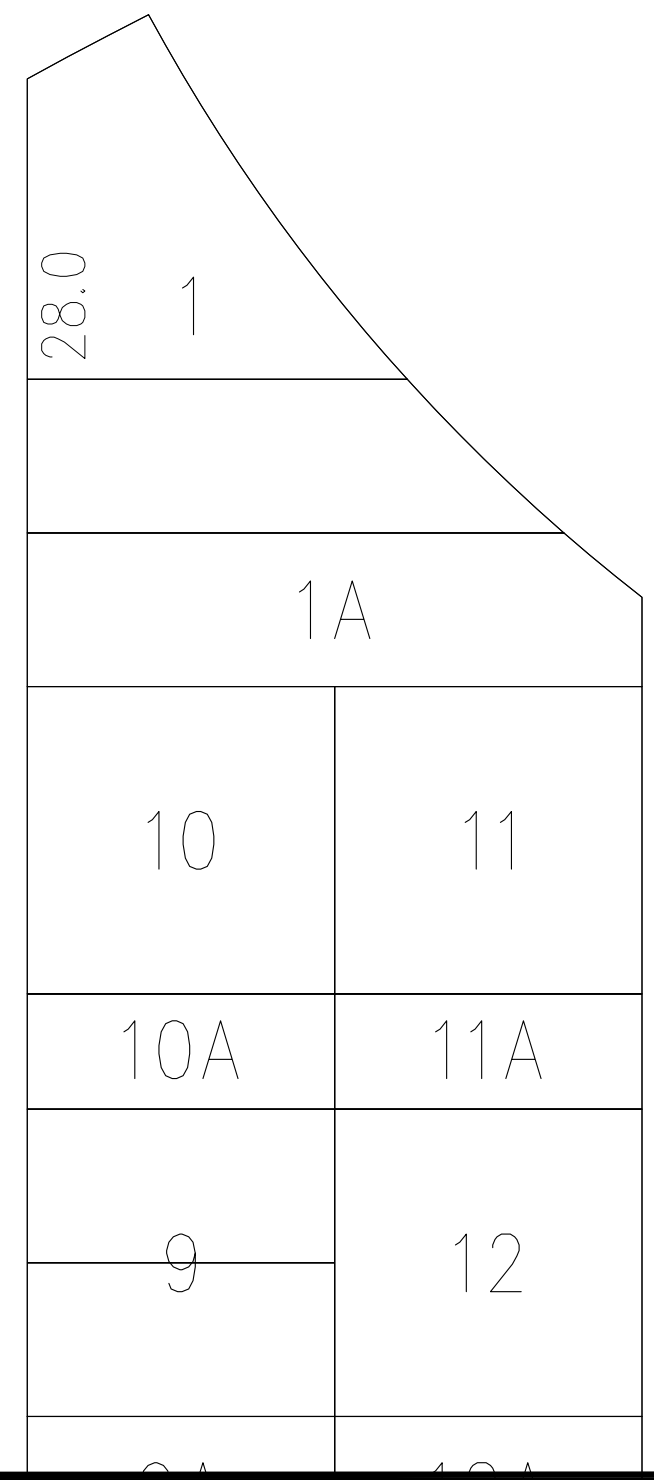
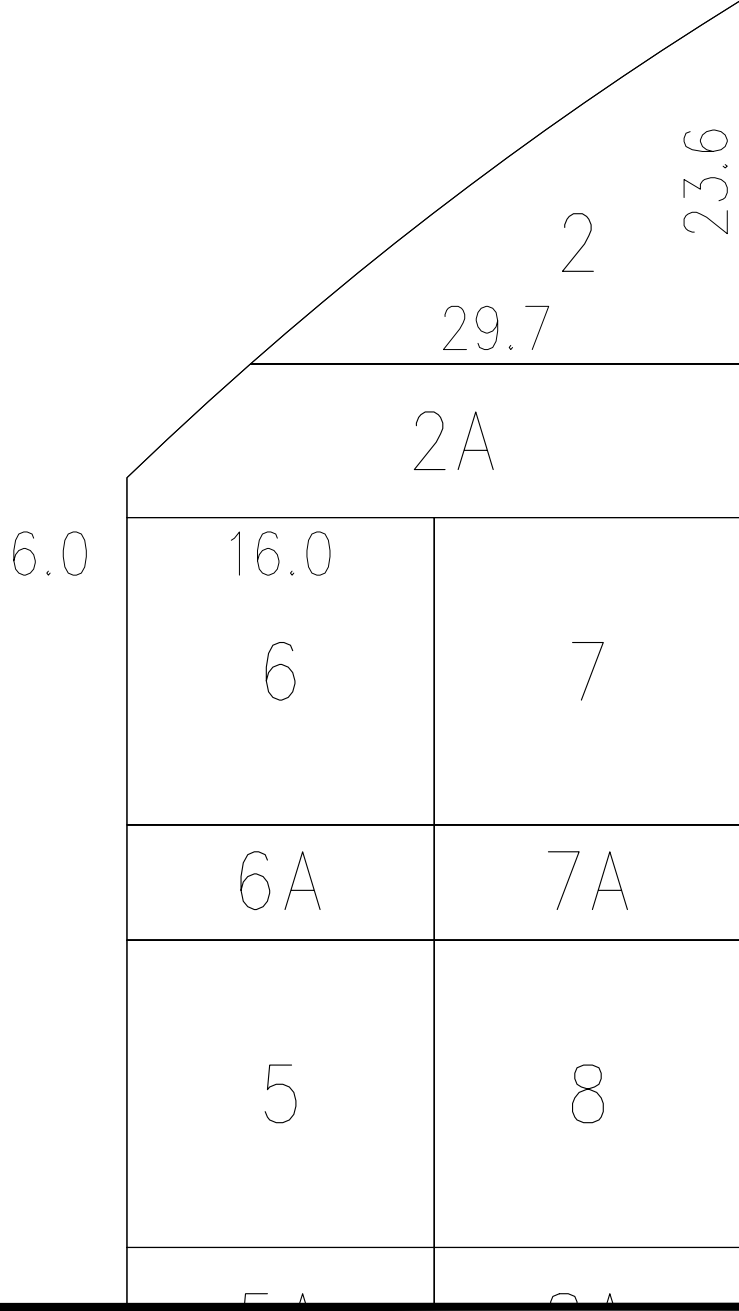
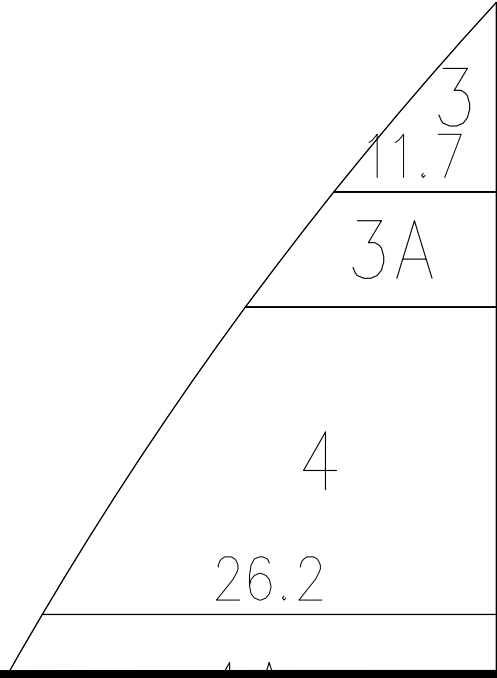
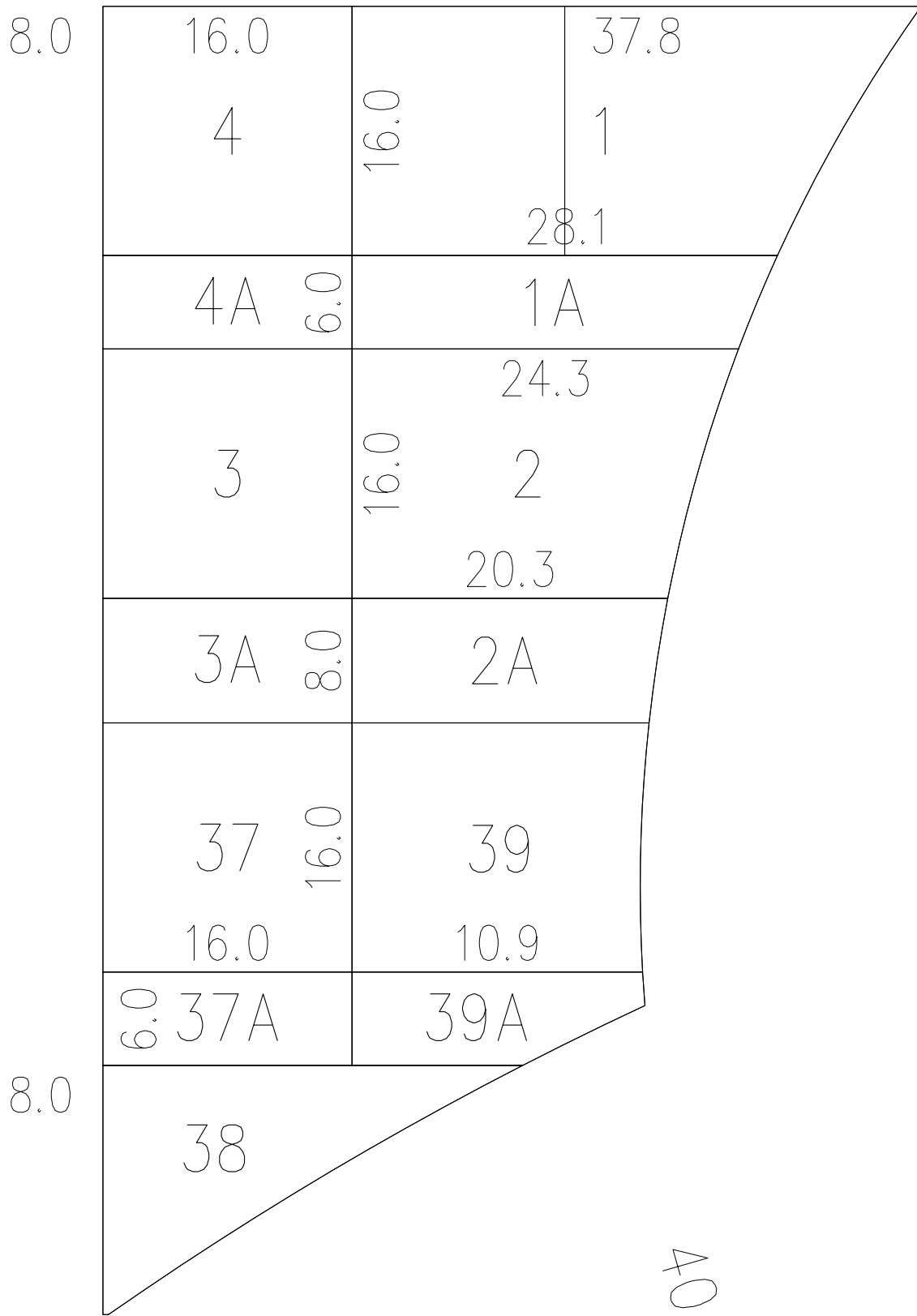
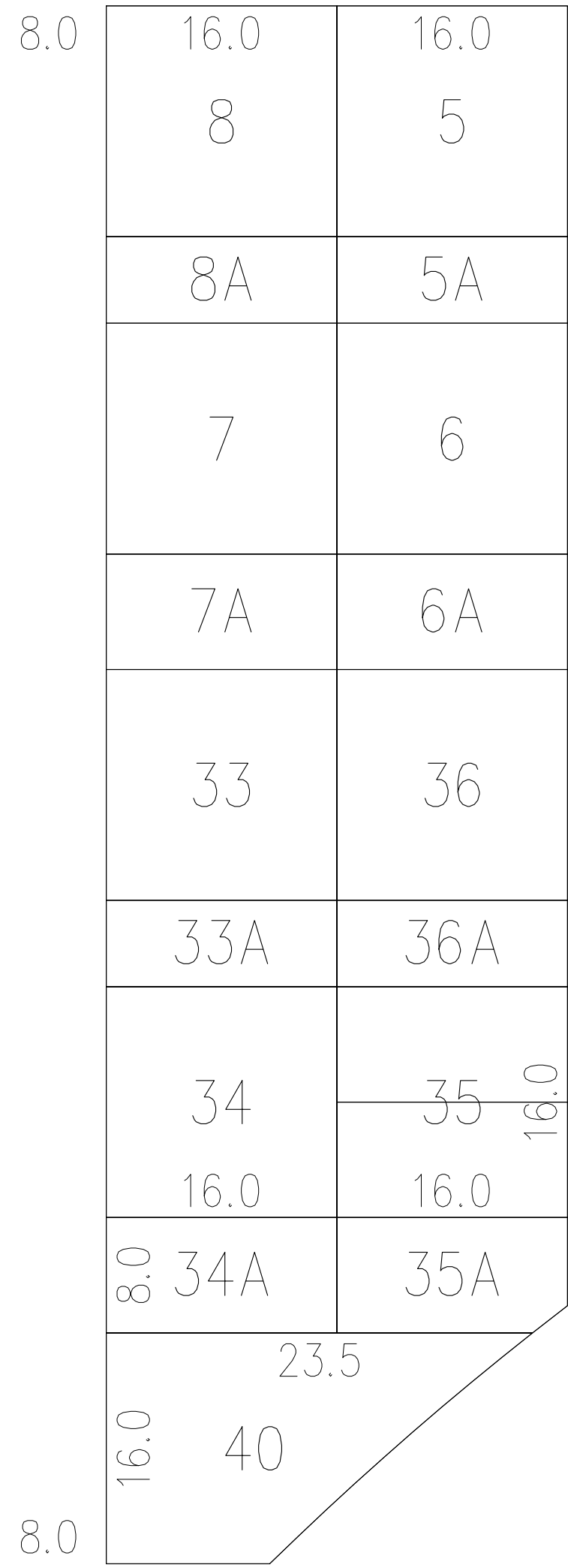

40.0

40.0

60.0

60.0

40.0

40.0

LOTS

SHT.- 07

PREPARED BY: MILLER & ASSOCIATES - 1111 CENTRAL AVENUE - KEARNEY, NE





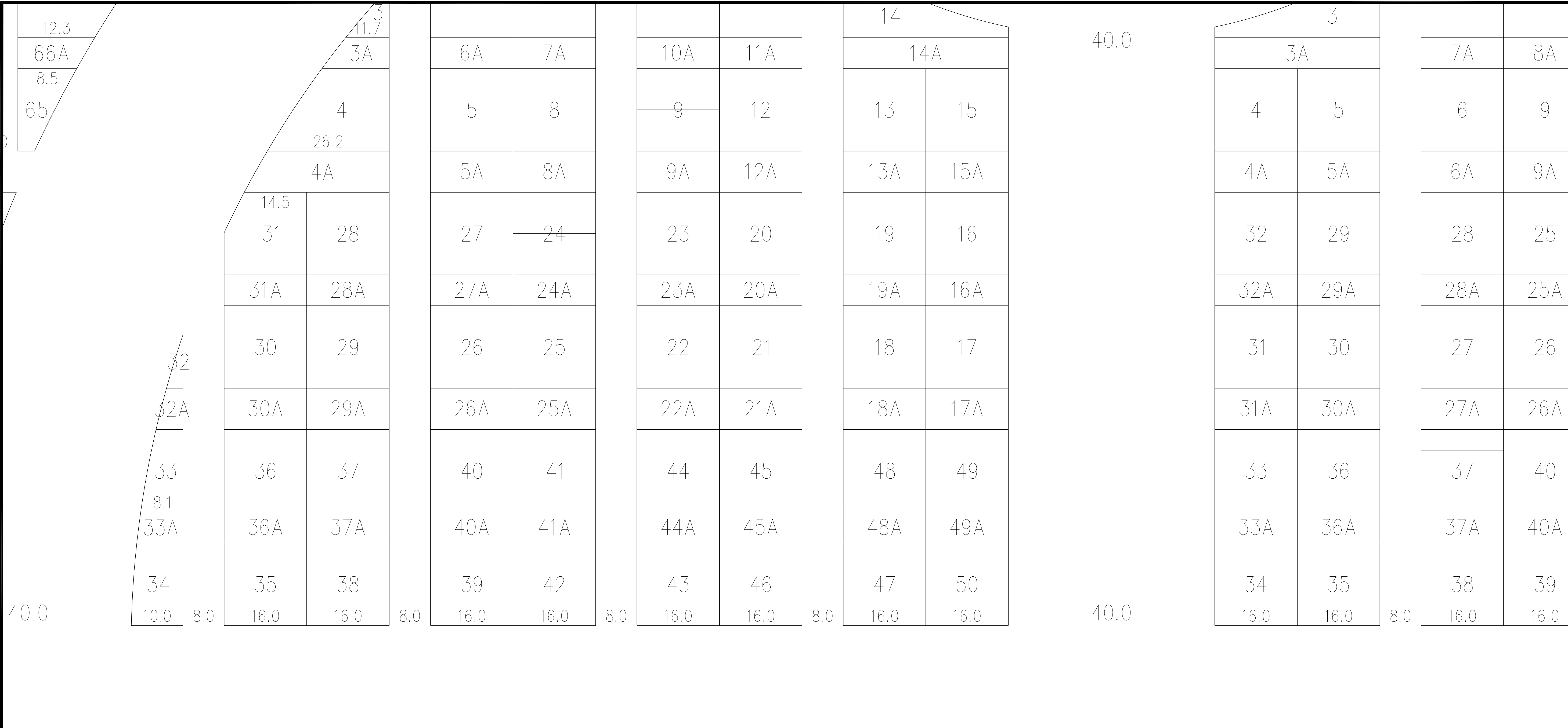

LOTS

SHT.- 08

PREPARED BY: MILLER & ASSOCIATES - 1111 CENTRAL AVENUE - KEARNEY, NE



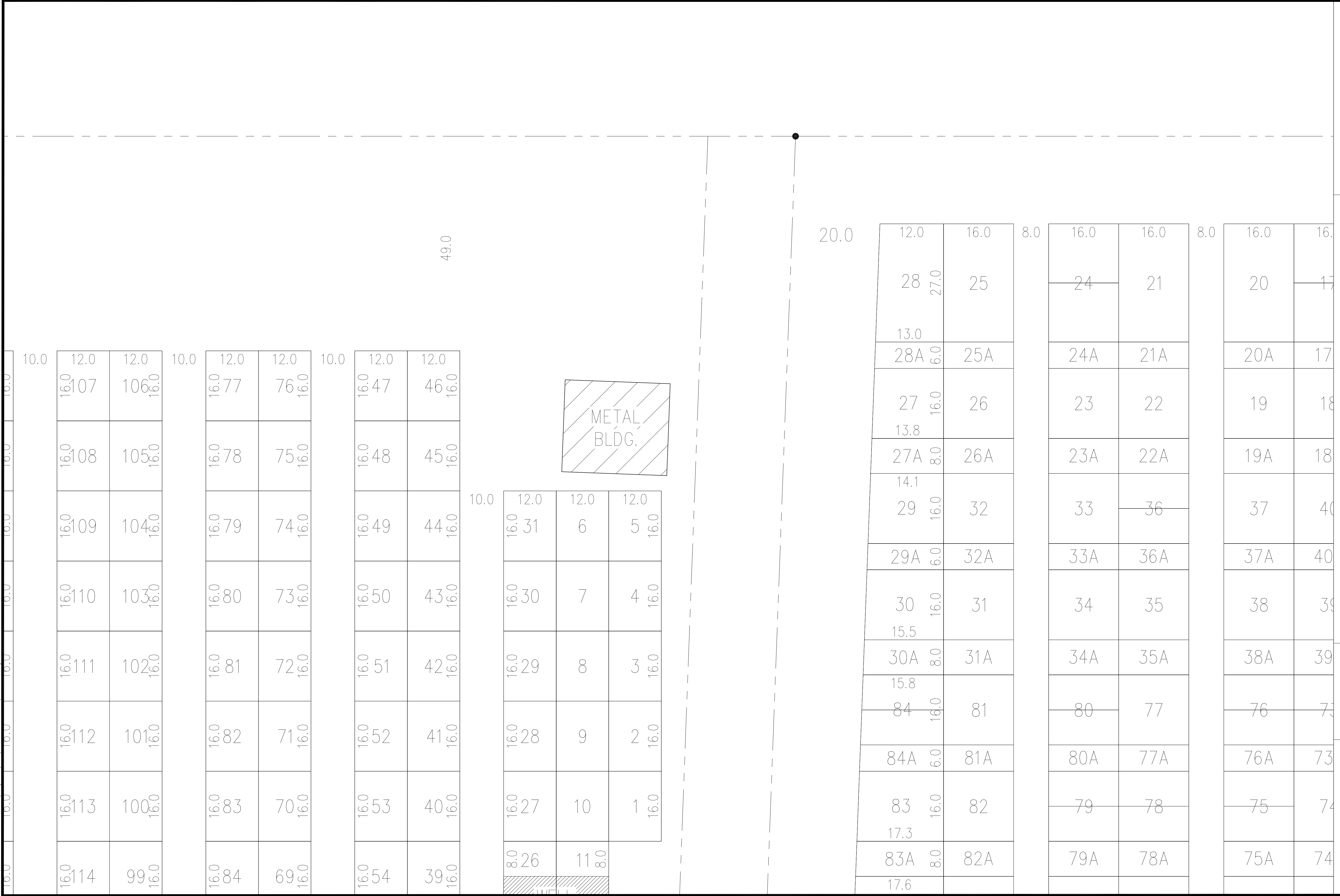

LOTS

SHT.- 09

PREPARED BY: MILLER & ASSOCIATES - 1111 CENTRAL AVENUE - KEARNEY, NE

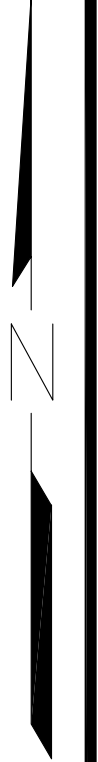

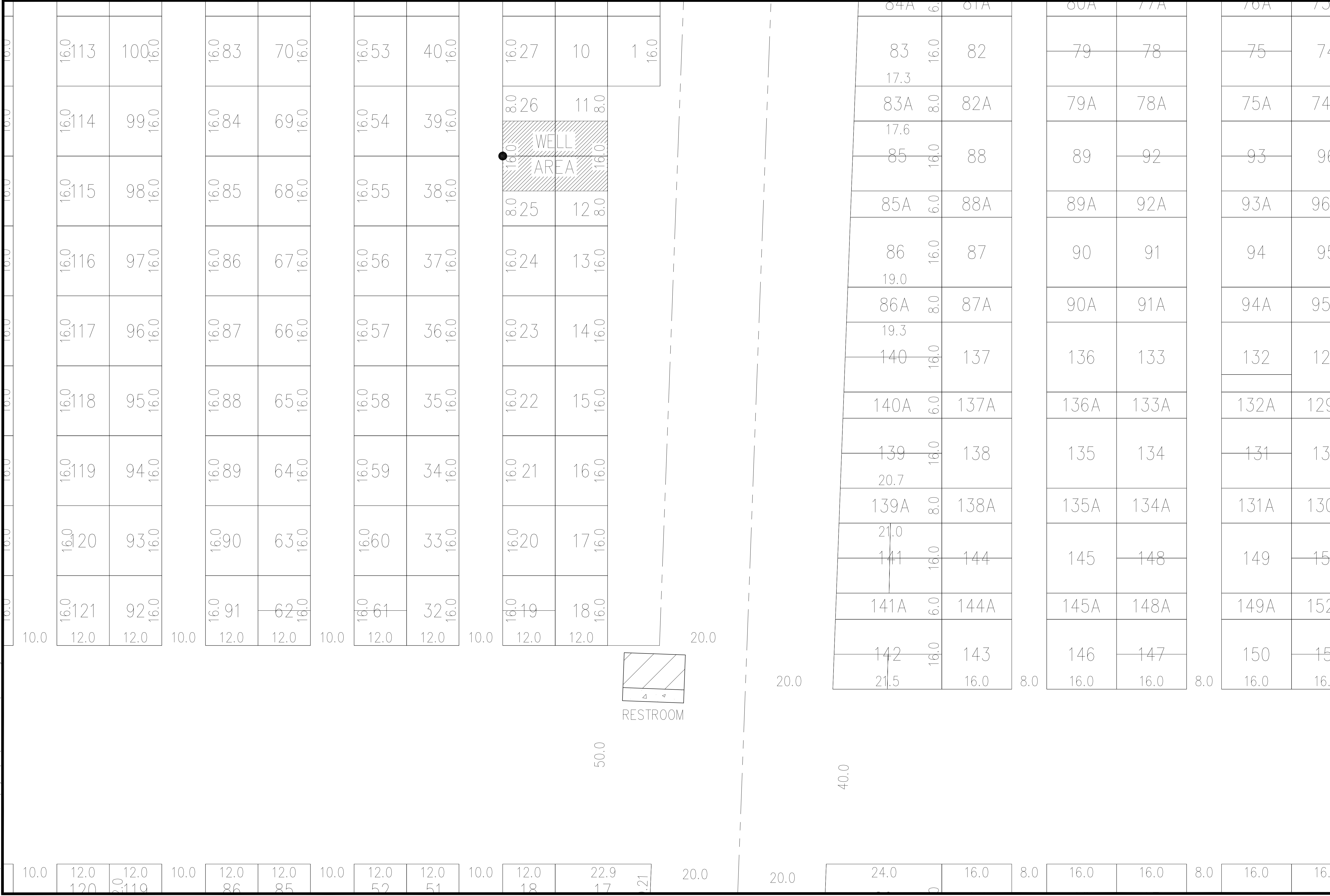

LOTS

SH.T. - 10

PREPARED BY: MILLER & ASSOCIATES - 1111 CENTRAL AVENUE - KEARNEY, NE

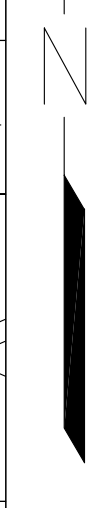

50

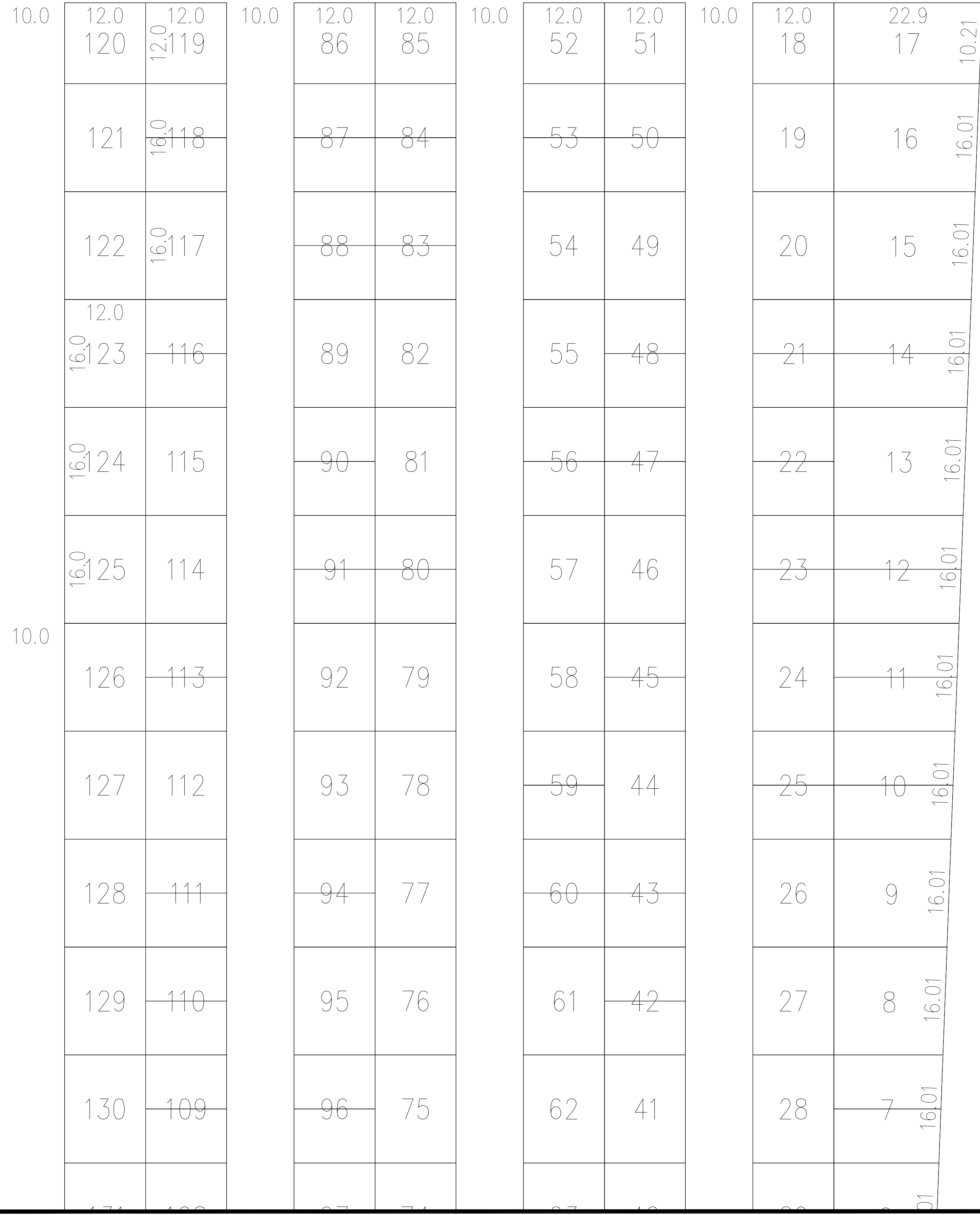

20.0

20.0

40.0

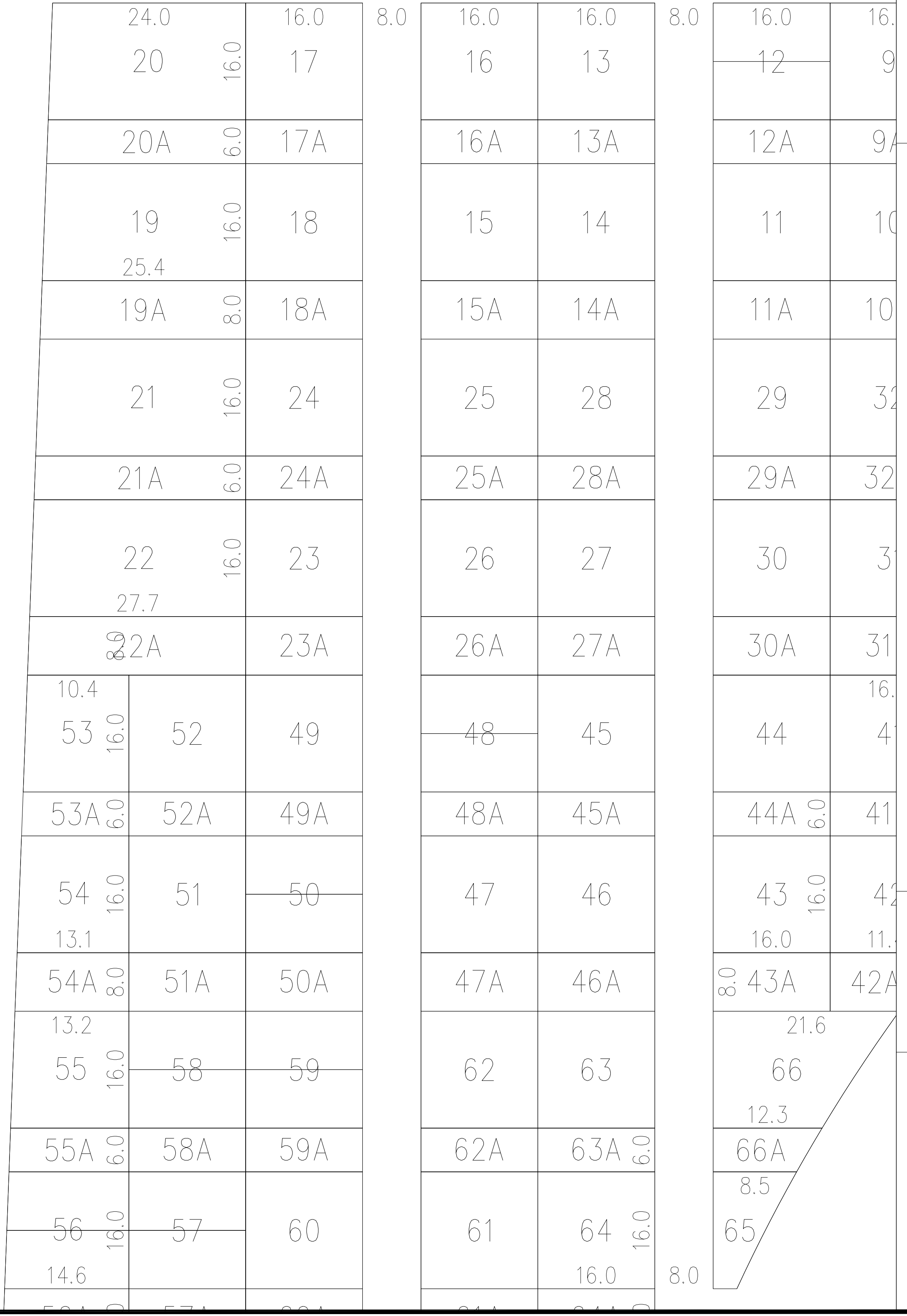

LOTS

SHT. - 11

PREPARED BY: MILLER & ASSOCIATES - 1111 CENTRAL AVENUE - KEARNEY, NE

N

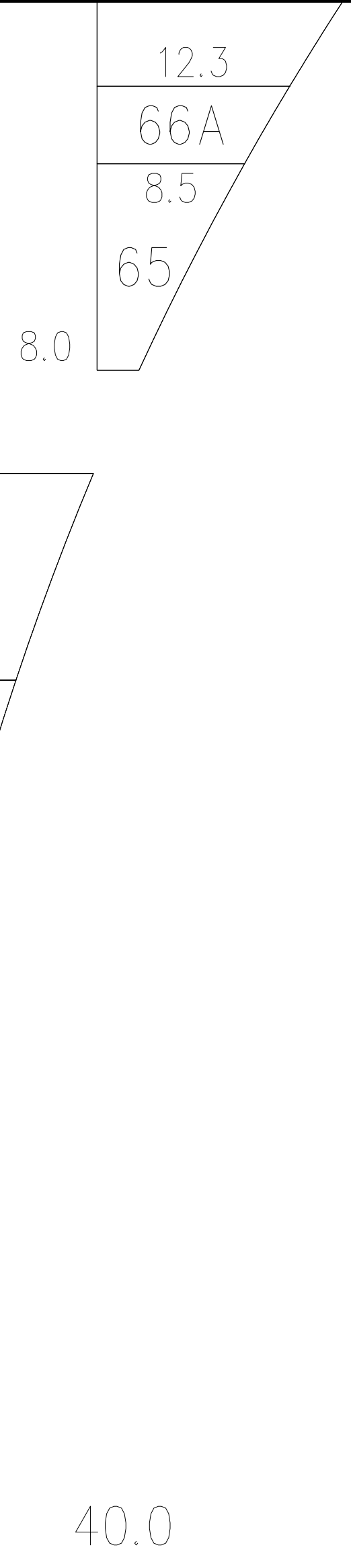
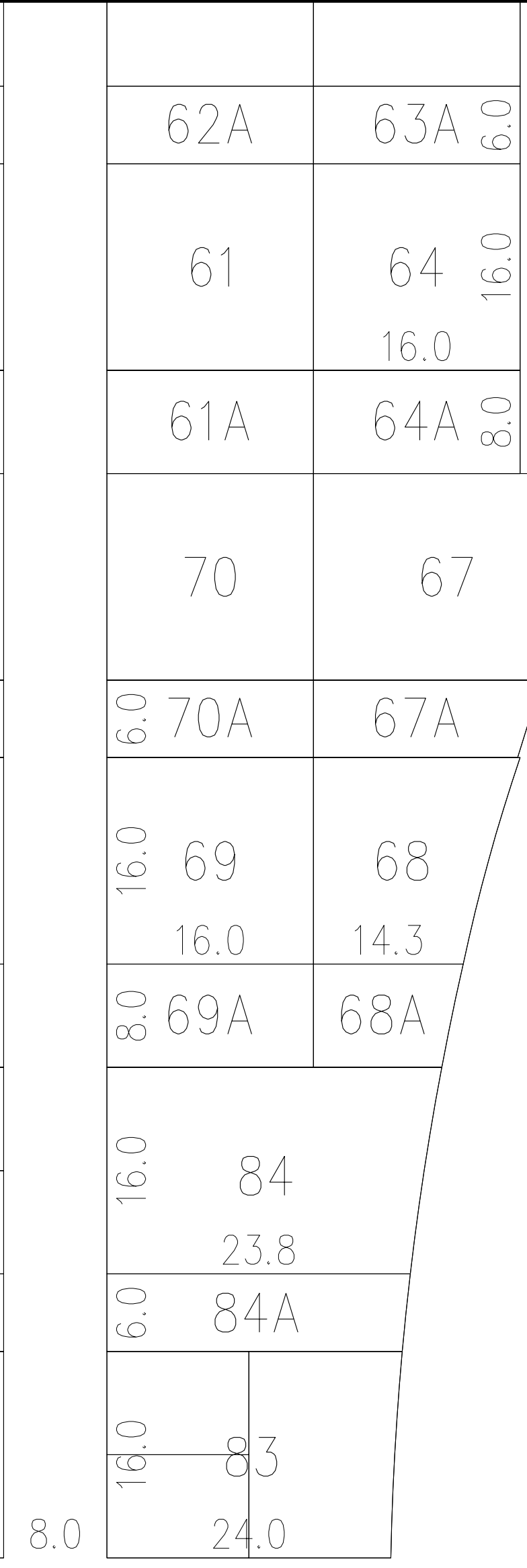
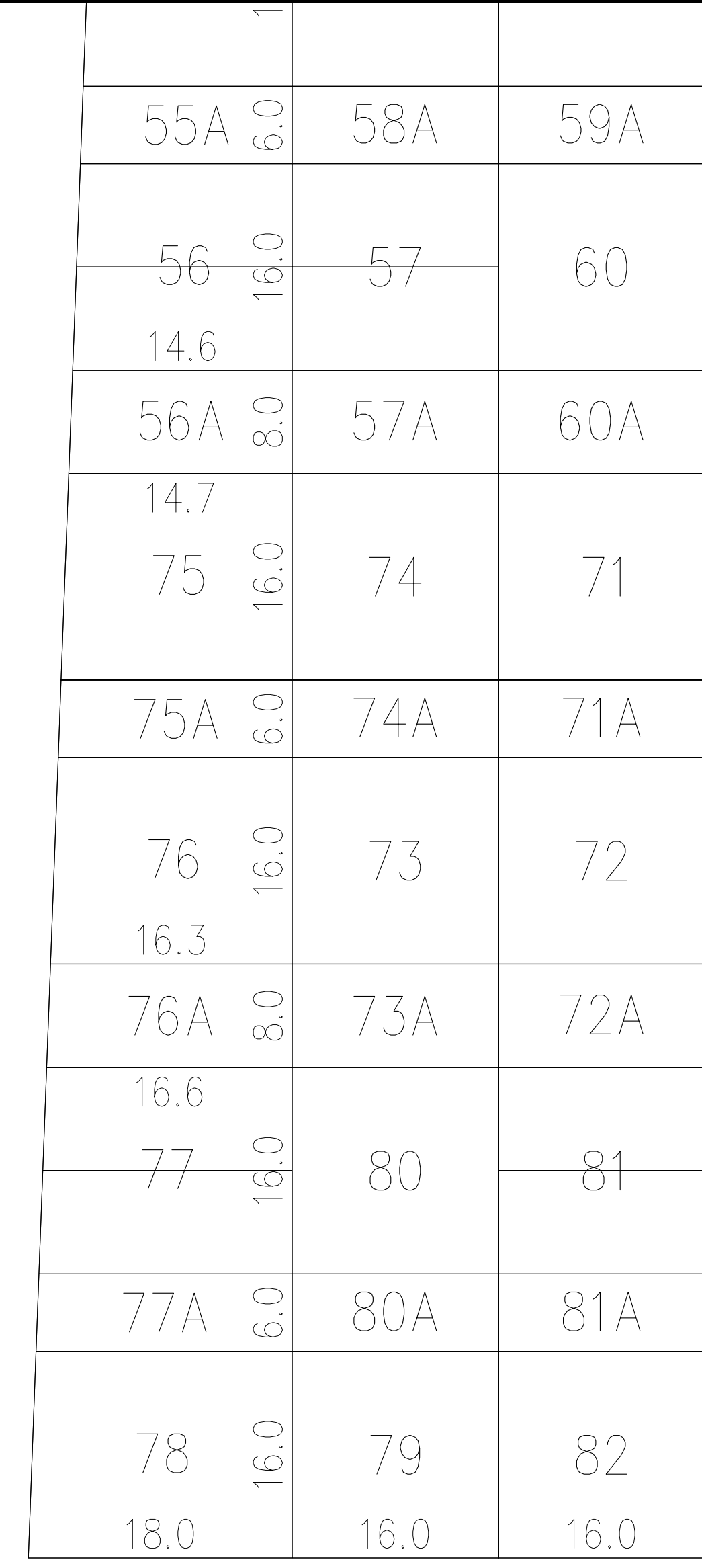
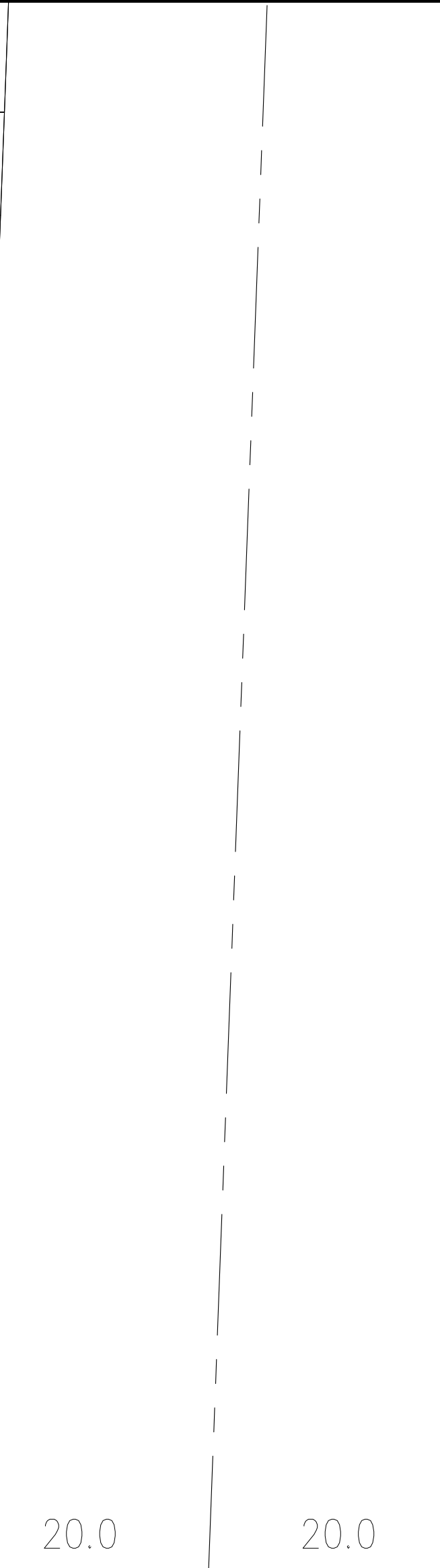
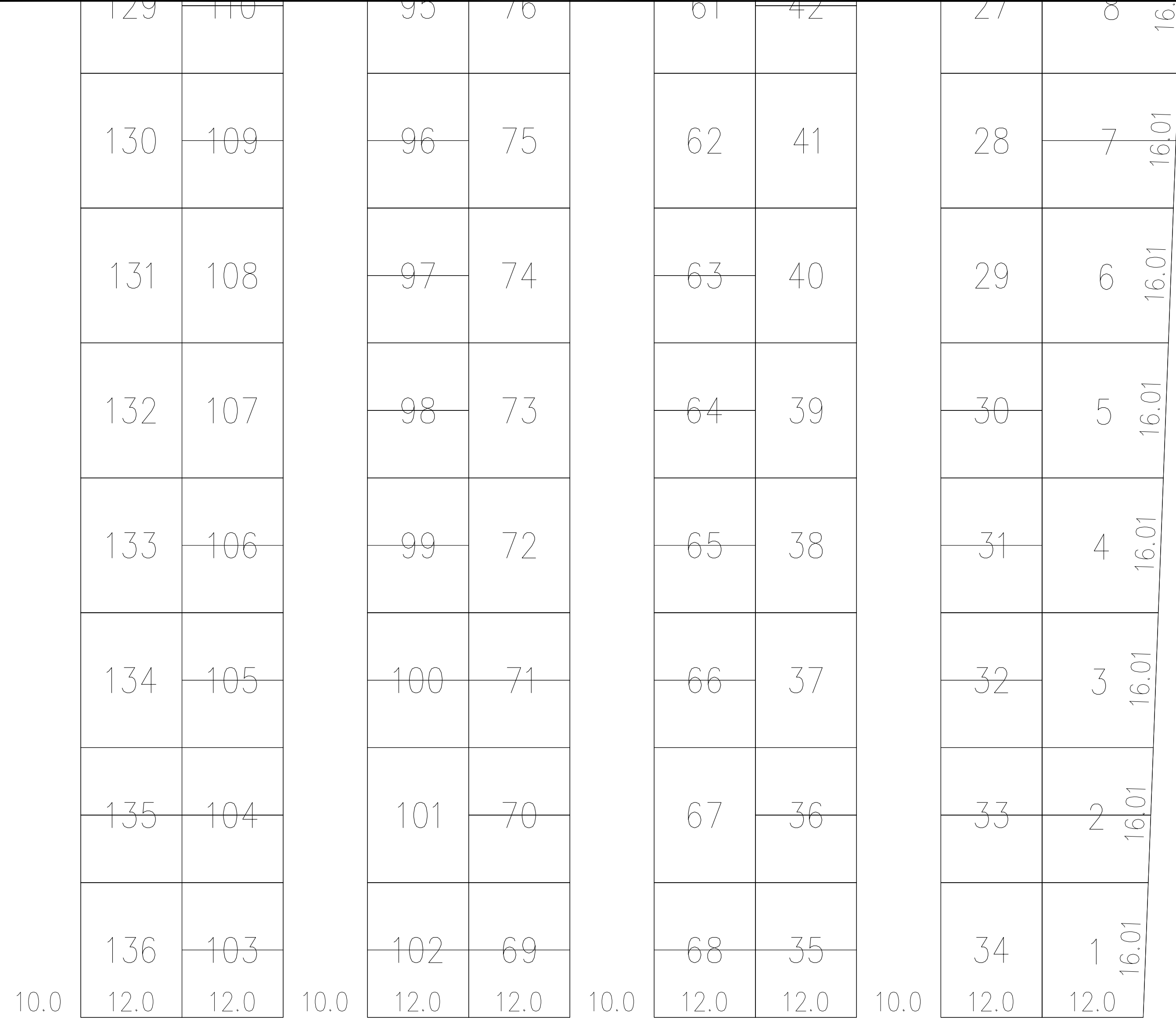

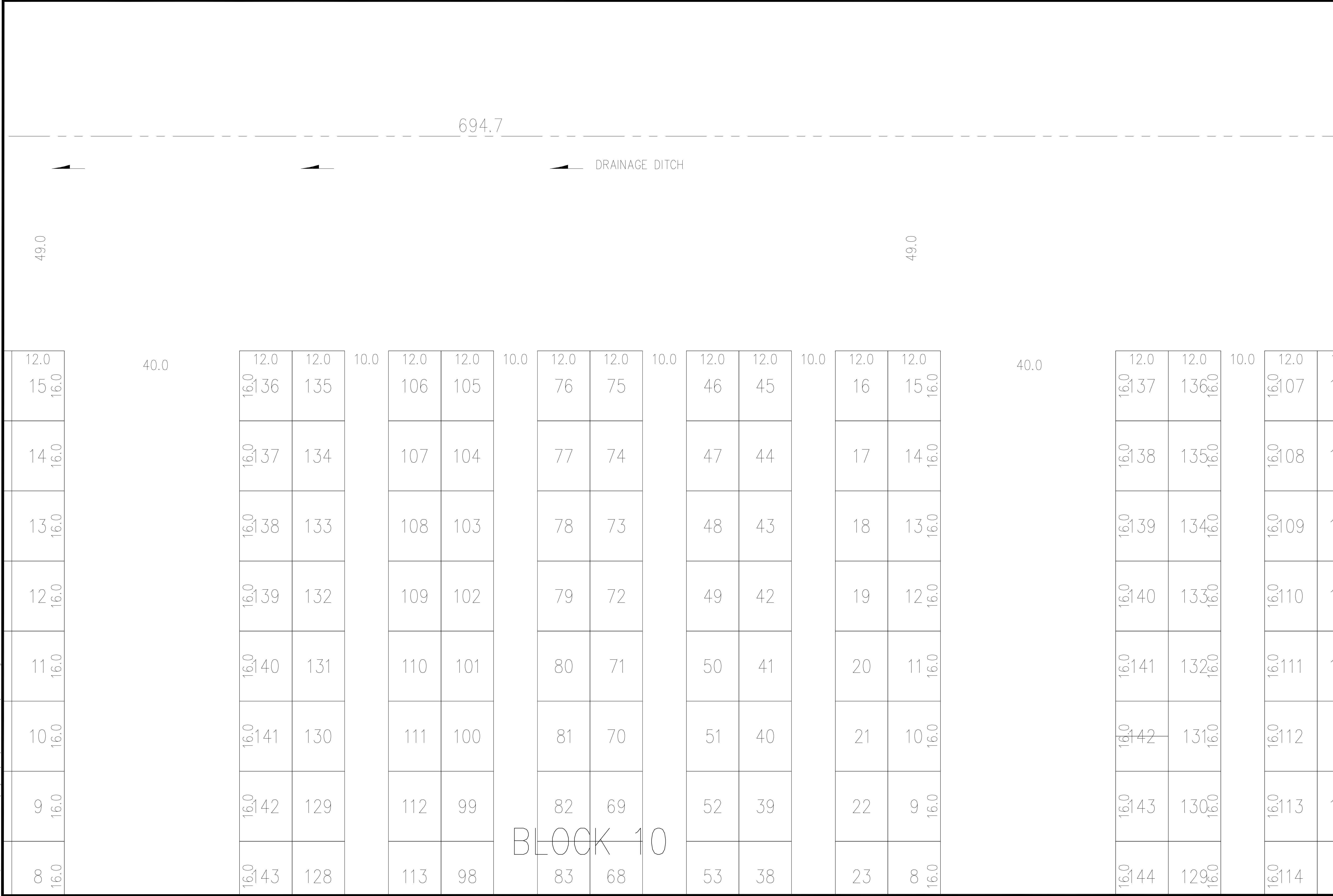

LOTS

SHIT.- 13

PREPARED BY: MILLER & ASSOCIATES - 1111 CENTRAL AVENUE - KEARNEY, NE

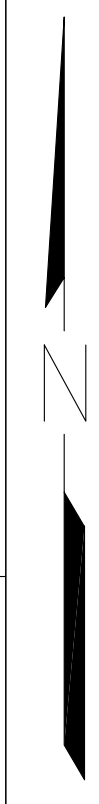

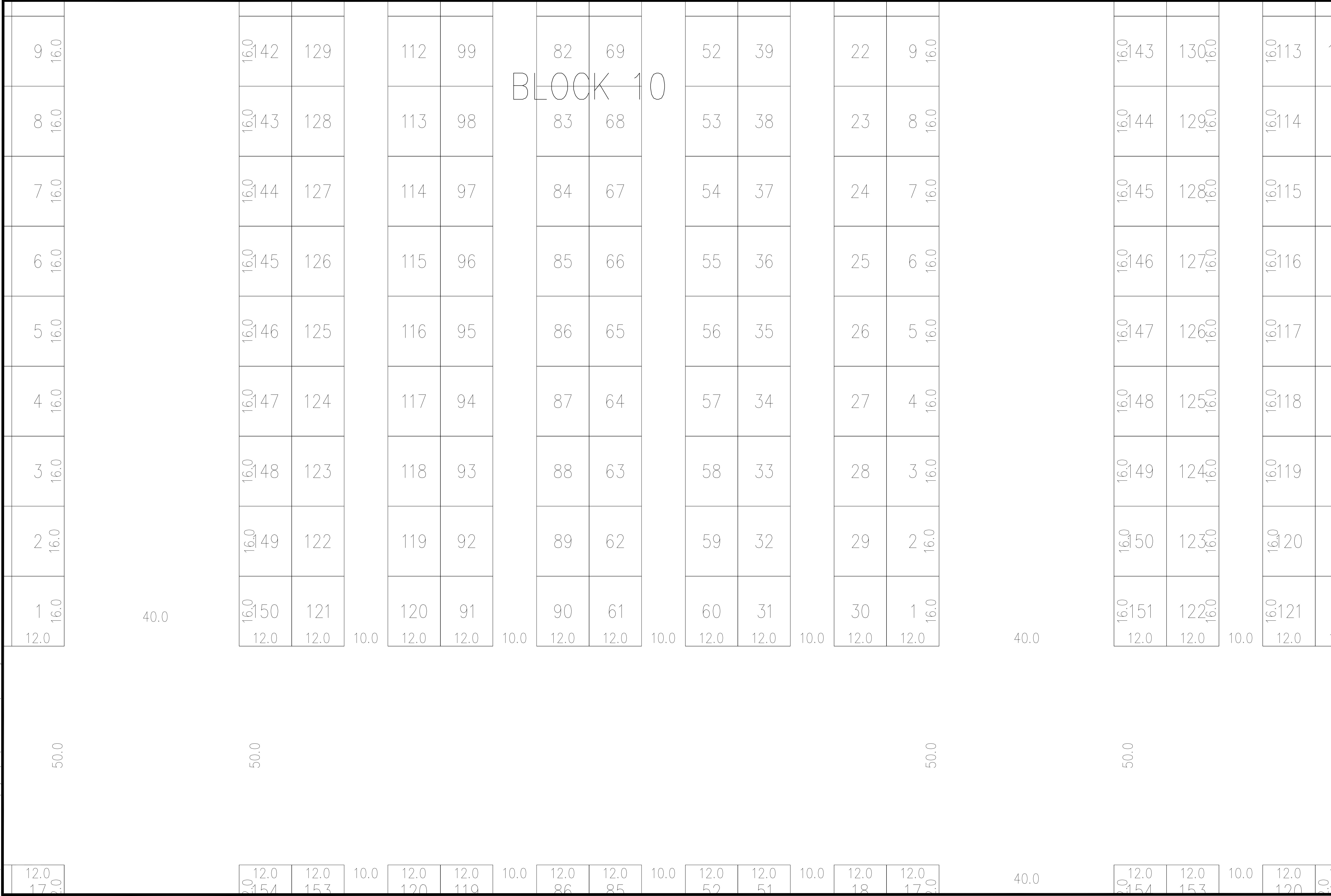

LOTS

SHT.- 14

PREPARED BY: MILLER & ASSOCIATES - 1111 CENTRAL AVENUE - KEARNEY, NE



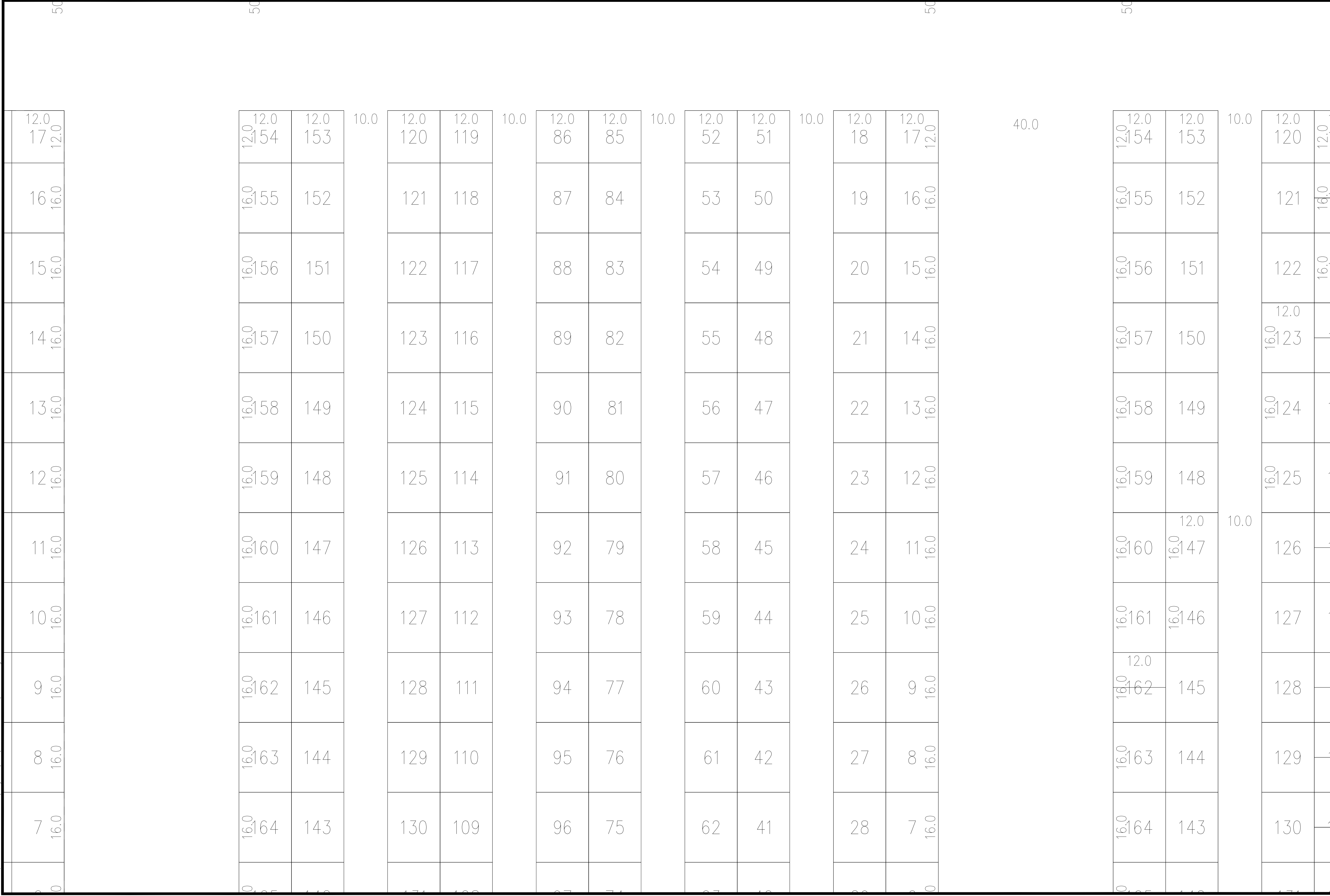

LOTS

SHT.- 15

PREPARED BY: MILLER & ASSOCIATES - 1111 CENTRAL AVENUE - KEARNEY, NE





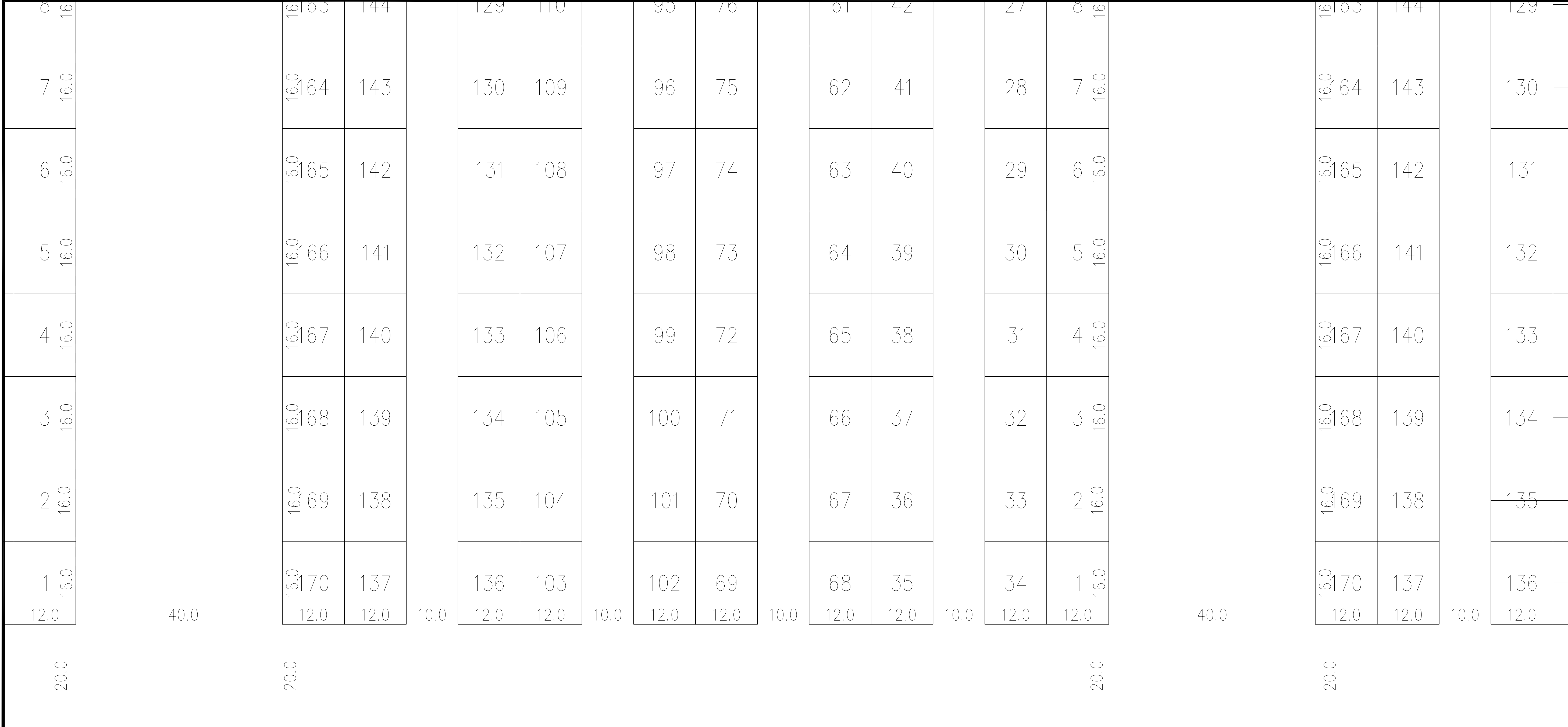

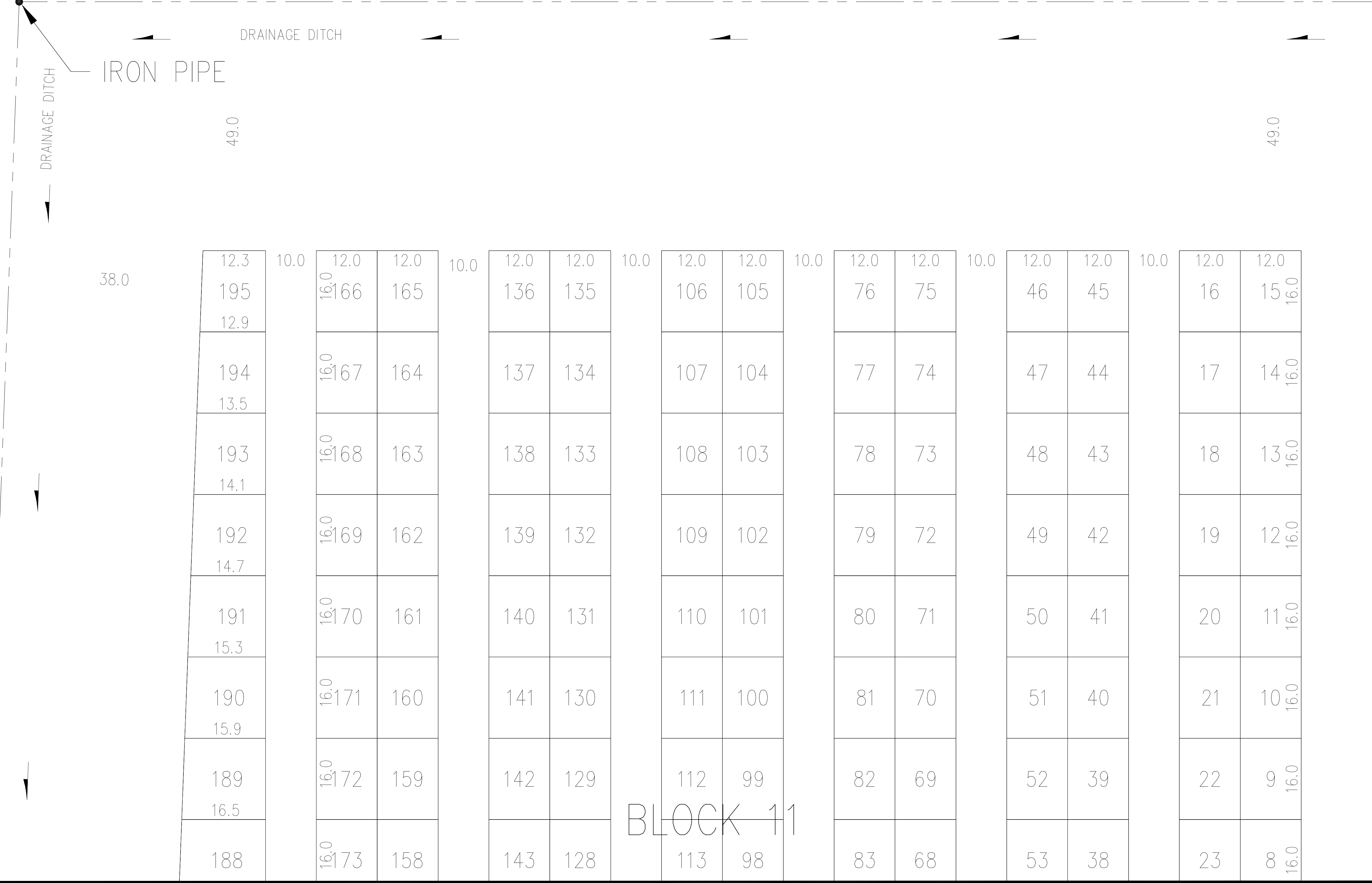

NOV 04, 2001 4:18:11:51 G:\Projects\126\126-01\2-01\SH1-18.dwg

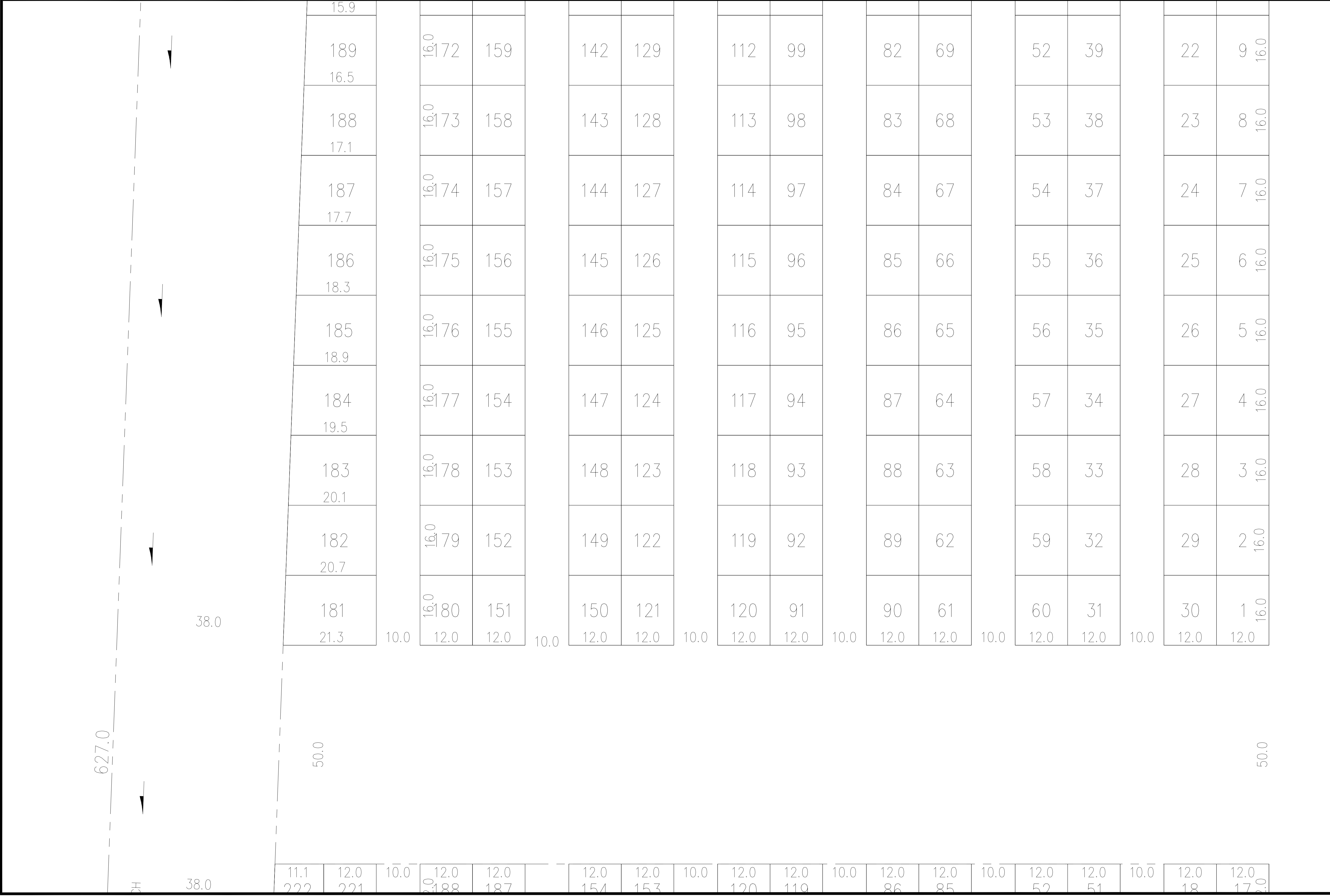

62

DRAINAGE DITCH

38.0

50

11.1 222 11.6	12.0 221	10.0	12.0 188	12.0 187	12.0 154	12.0 153	10.0	12.0 120	12.0 119	10.0	12.0 86	12.0 85	10.0	12.0 52	12.0 51	10.0	12.0 18	12.0 17	12.0
223 12.2	220		16.0 189	186	155	152		121	118		87	84		53	50		19	16	16.0
224 12.8	219		16.0 190	185	156	151		122	117		88	83		54	49		20	15	16.0
225 13.4	218		16.0 191	184	157	150		123	116		89	82		55	48		21	14	16.0
226 14.0	217		16.0 192	183	158	149		124	115		90	81		56	47		22	13	16.0
227 14.6	216		16.0 193	182	159	148		125	114		91	80		57	46		23	12	16.0
228 15.2	215		16.0 194	181	160	147		126	113		92	79		58	45		24	11	16.0
229 15.8	214		16.0 195	180	161	146		127	112		93	78		59	44		25	10	16.0
230 16.4	213		16.0 196	179	162	145		128	111		94	77		60	43		26	9	16.0
231 17.0	212		16.0 197	178	163	144		129	110		95	76		61	42		27	8	16.0
232 17.6	211		16.0 198	177	164	143		130	109		96	75		62	41		28	7	16.0

50

